

Docklocs®

OVERDENTURE ATTACHMENT SYSTEM

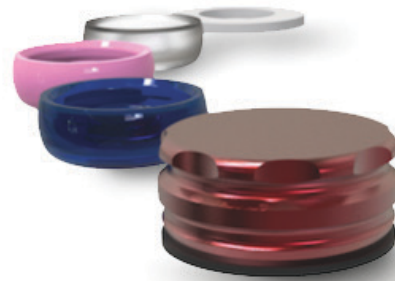

Ordering Information



The New Standard in Overdenture Attachment Systems

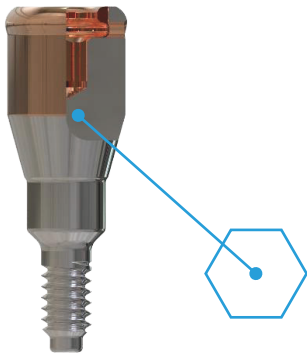

Innovative Coating Technology

Patented

Our patented fully **biocompatible ceramic PVD (physical vapor deposition) coating** provides many advantages over alternative abutment coatings. Comprised of a tremendously hard layer of **Zirconium Carbonitride (ZrCN)**, the abutment coating is more resistant to abrasion and wear compared to other common coatings. Additionally, its impressive rose gold tone blends well with the gingiva and provides a premium appearance.

Dual Abutment Drive Mechanism

In addition to the compatible **tri-lobe drive mechanism**, Docklocs abutments feature a **1,25 mm hex drive mechanism** in the center of the abutment for simple seating using commonly available drivers. This ensures that the abutments meet the needs of a wide variety of clinicians without requiring the purchase of additional tooling.

Precision Retention Inserts in Two Variations

Nylon (Industry Standard)

Retention inserts are a critical component of any overdenture attachment system and it is vital that their performance be consistently high to maintain patient satisfaction. The indispensable experience of our expert engineers ensures the performance and functionality of Docklocs retention inserts meet or exceed your expectations. Nylon retention inserts have evolved over the past 15 years to be the industry standard with high patient satisfaction.

High Performance Polyamide

These retention inserts have a lower tendency to absorb water and a high resistance to chemicals and fats, including alcoholic disinfectants. The inserts are extremely durable and have an excellent dynamic load capacity.

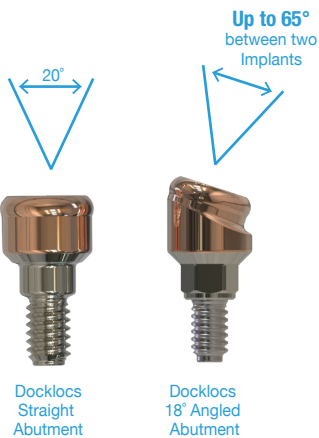

18° Angled Abutments

The availability of 18° angled abutments allows for the restoration of implants with up to 65° of divergence between them. This is a vast improvement over competitive systems that are not indicated for divergence over 20°. Further simplifying abutment placement are Docklocs indexing features and set screws, which allow angled abutments to be quickly and easily seated in the desired orientation.

Enhanced Denture Housings

Docklocs Denture Caps have an easily recognizable design that minimizes width and has grooves and enhanced anti-rotational flat sections for additional mechanical retention in the denture. For prostheses with thin acrylic, select the Docklocs anodized Denture Cap for a more aesthetic appearance. All Denture Caps are made from medical device grade titanium for superior performance.



Available All-in-One Packaging

Further adding to the convenience of the Docklocs Overdenture Attachment System is the availability of all-in-one packaging that contains all of the necessary items to complete a case on a single tray. This includes a denture housing and retention inserts in every variation of force as well as a parallel post and convenient abutment carrier for angled abutments. Contact us today for more information on available packaging.



| Part Number | Description | Price |
|-------------|-------------|-------|
|-------------|-------------|-------|

Processing Packs

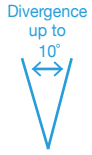

| | | | |
|---|---|--|--|
| A0055.S.ZT (2 Pack) A0055.T.ZT (10 Pack) | Standard Processing Pack Includes standard Denture Cap with black processing insert, three standard pivot retention levels and a block-out spacer | | |
| A0055.S.ZTA (2 Pack) A0055.T.ZTA (10 Pack) | Standard Processing Pack with Enhanced Cap Includes pink anodized Denture Cap with black processing insert, three standard pivot retention levels and a block-out spacer | | |
| A0056.S.ZT (2 Pack) A0056.T.ZT (10 Pack) | Extended Pivot Processing Pack Includes standard Denture Cap with black processing insert, three extended pivot retention levels and a block-out spacer | | |
| A0056.S.ZTA (2 Pack) A0056.T.ZTA (10 Pack) | Extended Pivot Processing Pack with Enhanced Cap Includes pink anodized Denture Cap with black processing insert, three extended pivot retention levels and a block-out spacer | | |



Denture Caps

| | | | |
|--|--|--|--|
| A0010.SZ (4 Pack) A0010.SZT (10 Pack) | Standard Denture Cap Assembly including black processing insert | | |
| A0011.SZ (4 Pack) A0011.SZT (10 Pack) | Denture Cap Assembly anodized pink including black processing insert | | |
| A0010.S (4 Pack) A0010.ST (10 Pack) | Enhanced Denture Cap Assembly red including black processing insert | | |

Standard Retention Inserts

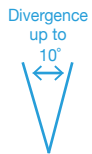

| | | | |
|--|------------------------------|--|--|
| A0002.SZ (4 Pack) A0002.SZT (20 Pack) | Blue Low Retention Insert | | |
| A0003.SZ (4 Pack) A0003.SZT (20 Pack) | Pink Medium Retention Insert | | |
| A0004.SZ (4 Pack) A0004.SZT (20 Pack) | Clear High Retention Insert | | |

Extended Pivot Retention Inserts

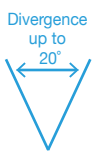

| | | | |
|--|---|--|--|
| A0001.SZ (4 Pack) A0001.SZT (20 Pack) | Gray Zero Retention Extended Pivot Insert | | |
| A0005.SZ (4 Pack) A0005.SZT (20 Pack) | Red Low Retention Extended Pivot Insert | | |
| A0006.SZ (4 Pack) A0006.SZT (20 Pack) | Orange Medium Retention Extended Pivot Insert | | |
| A0007.SZ (4 Pack) A0007.SZT (20 Pack) | Green High Retention Extended Pivot Insert | | |

Docklocs High Performance Polyamide (HPP) Retention Inserts

Low tendency to absorb water and high resistance to chemicals and fats.
 Available in Processing Pack configurations or Replacement Packs in quantities of 8 per package.
 Conveniently packaged on trays for easy pickup with the Docklocs Universal Tool.



Standard Processing Pack

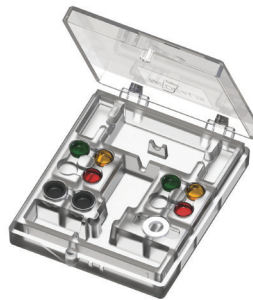

Extended Pivot Processing Pack



Blue HPP Replacement Insert 8-Pack

| Part Number | Description | Price |
|-------------|-------------|-------|
|-------------|-------------|-------|

Processing Packs with High Performance Polyamide Retention Inserts

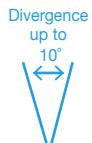

| | | | |
|--------------------|---|--|--|
| A0050.S.T (2 Pack) | Standard Processing Pack with HPP Retention Inserts Includes Enhanced Denture Cap with black processing insert, three standard pivot HPP retention levels and a block-out spacer | | |
| A0051.S.T (2 Pack) | Extended Pivot Processing Pack with HPP Retention Inserts Includes Enhanced Denture Cap with black processing insert, three extended pivot HPP retention levels and a block-out spacer | | |



Standard High Performance Polyamide Retention Inserts

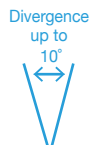







| | | | |
|---|----------------------------------|--|--|
| A0002.S4 (4 Pack) A0002.S8 (8 Pack) A0002.S20 (20 Pack) | Blue HPP Low Retention Insert | | |
| A0003.S4 (4 Pack) A0003.S8 (8 Pack) A0003.S20 (20 Pack) | Pink HPP Medium Retention Insert | | |
| A0004.S4 (4 Pack) A0004.S8 (8 Pack) A0004.S20 (20 Pack) | Clear HPP High Retention Insert | | |

Extended Pivot High Performance Polyamide Retention Inserts





| | | | |
|---|---|--|--|
| A0001.S4 (4 Pack) A0001.S8 (8 Pack) A0001.S20 (20 Pack) | Gray HPP Zero Retention Extended Pivot Insert | | |
| A0005.S4 (4 Pack) A0005.S8 (8 Pack) A0005.S20 (20 Pack) | Red HPP Low Retention Extended Pivot Insert | | |
| A0006.S4 (4 Pack) A0006.S8 (8 Pack) A0006.S20 (20 Pack) | Orange HPP Medium Retention Extended Pivot Insert | | |
| A0007.S4 (4 Pack) A0007.S8 (8 Pack) A0007.S20 (20 Pack) | Green HPP High Retention Extended Pivot Insert | | |

| Part Number | Description | | Price |
|--|--|---|-------|
| Lab Processing | | | |
| A0014.SZ (4 Pack) A0014.SZT (20 Pack) | Abutment Lab Analog (4mm Diameter) |  | |
| A0026.SZ (4 Pack) A0026.SZT (20 Pack) | Angled Abutment Lab Analog (4mm Diameter) |  | |
| A0015.SZ (4 Pack) A0015.SZT (20 Pack) | Impression Coping (includes black processing insert) |  | |
| A0012.SZ (4 Pack) A0012.SZT (20 Pack) | Processing Spacer |  | |

| | | | |
|---|--|---|--|
| Bar Components | | | |
| A0102.S (2 Pack) A0102.Z (10 Pack) | Docklocs Abutment for Bar, 2.0mm Thread |  | |
| A0017.SZ (4 Pack) A0017.SZT (20 Pack) | Yellow Bar Processing Insert |  | |
| A0011.SZB (4 Pack) A0011.SZBT (10 Pack) | Bar Cap Assembly - Enhanced Cap Includes: Pink Titanium Denture Cap with Yellow Bar Processing Insert |  | |
| A0057.S.ZTA (2 Pack) A0057.T.ZTA (10 Pack) | Bar Processing Pack Assembly with Enhanced Cap |  | |
| A0010.SZB (4 Pack) A0010.SZBT (10 Pack) | Bar Cap Assembly - Standard Cap Includes: Titanium Denture Cap with Yellow Bar Processing Insert |  | |
| A0057.S.ZT (2 Pack) A0057.T.ZT (10 Pack) | Bar Processing Pack Assembly with Standard Cap |  | |

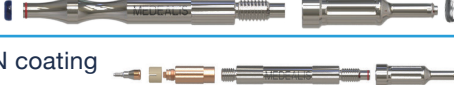
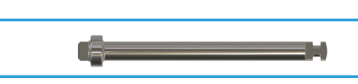
| | | | |
|--|-------------------------|---|--|
| Replacement Components | | | |
| A0008.SZ (4 Pack) A0008.SZT (20 Pack) | Black Processing Insert |  | |
| A0009.SZ (20 Pack) | Block-Out Spacer |  | |

| | | | |
|--------------------------|--|---|--|
| Tools and Drivers | | | |
| A0013 | Angle Measurement Guide |  | |
| A0019 | Universal Tool, 2-Piece |  | |
| A0020 | Universal Tool, 4-Piece with ZrCN coating and PEEK Abutment Holder |  | |
| A0022 | Tri-Lobe Driver for Latch Handpiece |  | |
| A0023 | Tri-Lobe Driver for Latch Handpiece with PEEK Abutment Holder |  | |
| A0025 | Hexagonal Driver for Latch Handpiece, 1,25mm Tip |  | |

Docklocs Straight Abutments are conveniently packed in protective plastic vials for familiarity and minimal waste.



| Straight Abutments | Cuff Height | | | | | | |
|--------------------|------------------|-----|-----|-----|-----|-----|-----|
| | Implant Platform | 0mm | 1mm | 2mm | 3mm | 4mm | 5mm |

Bego

| | | | | | | | |
|--|--|---------|---------|---------|---------|---------|--|
| Sub-Tec S / RI / RS / RSX 3.75mm-4.1mm | | B0001.H | B0002.H | B0003.H | B0004.H | B0005.H | |
| Sub-Tec S / RI / RS / RSX 4.5 mm | | B0011.H | B0012.H | B0013.H | B0014.H | B0015.H | |

BioHorizons®

| | | | | | | | |
|--|----------|----------|----------|----------|----------|----------|--|
| Tapered Internal Implant System 3.5 mm | BH0000.H | BH0001.H | BH0002.H | BH0003.H | BH0004.H | BH0005.H | |
| Tapered Internal Implant System 4.5 mm | BH0010.H | BH0011.H | BH0012.H | BH0013.H | BH0014.H | BH0015.H | |
| Tapered Internal Implant System 5.7 mm | | BH0021.H | BH0022.H | BH0023.H | BH0024.H | BH0025.H | |

Bredent

| | | | | | | | |
|----------|--|----------|----------|----------|----------|--|----------|
| SKY® | | BR0001.H | BR0002.H | BR0003.H | BR0004.H | | BR0006.H |
| copaSKY® | | BR0011.H | BR0012.H | BR0013.H | BR0014.H | | BR0016.H |

CAMLOG®

| | | | | | | | |
|-----------------|--|---------|---------|---------|---------|---------|--|
| iSy® | | C0001.H | C0002.H | C0003.H | C0004.H | C0005.H | |
| CAMLOG® 3.3 mm | | C0011.H | C0012.H | C0013.H | C0014.H | C0015.H | |
| CAMLOG® 3.8 mm | | C0021.H | C0022.H | C0023.H | C0024.H | C0025.H | |
| CAMLOG® 4.3 mm | | C0031.H | C0032.H | C0033.H | C0034.H | C0035.H | |
| CAMLOG® 5.0 mm | | C0041.H | C0042.H | C0043.H | C0044.H | C0045.H | |
| CONELOG® 3.3 mm | | C0051.H | C0052.H | C0053.H | C0054.H | C0055.H | |
| CONELOG® 3.8 mm | | C0061.H | C0062.H | C0063.H | C0064.H | C0065.H | |
| CONELOG® 4.3 mm | | C0071.H | C0072.H | C0073.H | C0074.H | C0075.H | |
| CONELOG® 5.0 mm | | C0081.H | C0082.H | C0083.H | C0084.H | C0085.H | |

C-TECH IMPLANT

| | | | | | | | |
|--------------------|--|----------|----------|----------|----------|----------|----------|
| EL / Esthetic Line | | CT0001.H | CT0002.H | CT0003.H | CT0004.H | CT0005.H | CT0006.H |
|--------------------|--|----------|----------|----------|----------|----------|----------|

Dentsply Sirona®

| | | | | | | | |
|--|--|----------|----------|----------|----------|----------|---------|
| Astra OsseoSpeed® TX Aqua 3.5mm/4mm | | AS0001.H | AS0002.H | AS0003.H | AS0004.H | AS0005.H | |
| Astra OsseoSpeed® TX Lilac 4.5mm/5mm | | AS0011.H | AS0012.H | AS0013.H | AS0014.H | AS0015.H | |
| Astra OsseoSpeed® EV 3.6 mm | | AS0021.H | AS0022.H | AS0023.H | AS0024.H | AS0025.H | |
| Astra OsseoSpeed® EV & Profile EV 4.2 mm | | AS0031.H | AS0032.H | AS0033.H | AS0034.H | AS0035.H | |
| Astra OsseoSpeed® EV & Profile EV 4.8 mm | | AS0041.H | AS0042.H | AS0043.H | AS0044.H | AS0045.H | |
| Ankylos® C/X | | D0001.H | D0002.H | D0003.H | D0004.H | D0005.H | D0006.H |

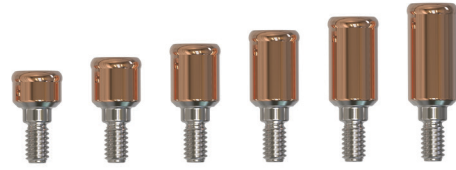

| Straight Abutments | Cuff Height | | | | | | | |
|--------------------|-------------|-----|-----|-----|-----|-----|-----|-----|
| | 0mm | 1mm | 2mm | 3mm | 4mm | 5mm | 6mm | 7mm |

Medentis

| | | | | | | | |
|-----|--|---------|---------|---------|---------|---------|--|
| ICX | | M0001.H | M0002.H | M0003.H | M0004.H | M0005.H | |
|-----|--|---------|---------|---------|---------|---------|--|

MegaGen

| | | | | | | | | |
|------------------|--|----------|----------|----------|----------|----------|----------|----------|
| AnyRidge® | | MG0001.H | MG0002.H | MG0003.H | MG0004.H | MG0005.H | MG0006.H | |
| AnyOne® Internal | | MG0021.H | MG0022.H | MG0023.H | MG0024.H | MG0025.H | MG0026.H | |
| AnyOne® Onestage | | MG0011.H | MG0012.H | MG0013.H | MG0014.H | MG0015.H | MG0016.H | |
| MINI™ | | MG0031.H | MG0032.H | MG0033.H | MG0034.H | MG0035.H | MG0036.H | |
| BLUEDIAMOND® NC | | MG0041.H | MG0042.H | MG0043.H | MG0044.H | MG0045.H | MG0046.H | |
| BLUEDIAMOND® RC | | MG0051.H | MG0052.H | MG0053.H | MG0054.H | MG0055.H | MG0056.H | MG0057.H |

Neodent®

| | | | | | | | |
|--------------|--|----------|----------|----------|----------|----------|----------|
| Grand Morse® | | NE0001.H | NE0002.H | NE0003.H | NE0004.H | NE0005.H | NE0006.H |
|--------------|--|----------|----------|----------|----------|----------|----------|

Nobel Biocare®

| | | | | | | | |
|-----------------------------------|---------|---------|---------|---------|---------|---------|---------|
| NobelReplace® Tri-Channel 3.5mm | N0000.H | N0001.H | N0002.H | N0003.H | N0004.H | N0005.H | N0006.H |
| NobelReplace® Tri-Channel 4.3mm | N0010.H | N0011.H | N0012.H | N0013.H | N0014.H | N0015.H | N0016.H |
| NobelReplace® Tri-Channel 5.0mm | | N0021.H | N0022.H | N0023.H | N0024.H | N0025.H | N0026.H |
| NobelActive® Conical NP | | N0031.H | N0032.H | N0033.H | N0034.H | N0035.H | N0036.H |
| NobelActive® Conical RP | | N0041.H | N0042.H | N0043.H | N0044.H | N0045.H | N0046.H |
| Brånemark System® External Hex NP | | N0051.H | N0052.H | N0053.H | N0054.H | N0055.H | N0056.H |
| Brånemark System® External Hex RP | | N0061.H | N0062.H | N0063.H | N0064.H | N0065.H | N0066.H |
| Brånemark System® External Hex WP | | N0071.H | N0072.H | N0073.H | N0074.H | N0075.H | |

Osstem® / Hiossen®

| | | | | | | | |
|--|--|---------|---------|---------|---------|---------|---------|
| TS System Mini (Yellow) ET System Mini (Yellow) | | O0001.H | O0002.H | O0003.H | O0004.H | O0005.H | O0006.H |
| TS System Regular (Green) ET System Regular (Green) | | O0011.H | O0012.H | O0013.H | O0014.H | O0015.H | O0016.H |



| Straight Abutments | Cuff Height | | | | | | |
|--------------------|-------------|-----|-----|-----|-----|-----|-----|
| | 0mm | 1mm | 2mm | 3mm | 4mm | 5mm | 6mm |

Southern Implants®

| | | | | | | | |
|------------------------------|----------|-----------|-----------|-----------|-----------|-----------|-----------|
| External Hex 3.0 mm | | SI0001.H | SI0002.H | SI0003.H | SI0004.H | SI0005.H | SI0006.H |
| External Hex 3.25 mm | | SI0011.H | SI0012.H | SI0013.H | SI0014.H | SI0015.H | SI0016.H |
| External Hex 4.0 mm | | SI0021.H | SI0022.H | SI0023.H | SI0024.H | SI0025.H | SI0026.H |
| Tri Nex® 3.5 mm | SI0070.H | SI0071.H | SI0072.H | SI0073.H | SI0074.H | SI0075.H | SI0076.H |
| Tri Nex® 4.3 mm | SI0080.H | SI0081.H | SI0082.H | SI0083.H | SI0084.H | SI0085.H | SI0086.H |
| Tri Nex® 5.0 mm | | SI0091.H | SI0092.H | SI0093.H | SI0094.H | SI0095.H | SI0096.H |
| Deep Conical 3.0 mm | | SI00101.H | SI00102.H | SI00103.H | SI00104.H | SI00105.H | SI00106.H |
| Deep Conical 3.5 mm / 4.0 mm | | SI00111.H | SI00112.H | SI00113.H | SI00114.H | SI00115.H | |
| Deep Conical 5.0 mm | | SI00121.H | SI00122.H | SI00123.H | SI00124.H | SI00125.H | |
| Internal Hex/Provata | SI0040.H | SI0041.H | SI0042.H | SI0043.H | SI0044.H | SI0045.H | SI0046.H |
| Internal Provata 3.3 mm | | | SI0052.H | | SI0054.H | | |
| IT Connection 4.8 mm | | SI00131.H | SI00132.H | SI00133.H | SI00134.H | SI00135.H | SI00136.H |
| IT Connection 6.5 mm | | SI00141.H | SI00142.H | SI00143.H | SI00144.H | SI00145.H | SI00146.H |
| SP1 | | SI00151.H | SI00152.H | SI00153.H | SI00154.H | SI00155.H | SI00156.H |

Straumann®

| | | | | | | | |
|------------------|--|---------|---------|---------|---------|---------|---------|
| Bone Level NC | | S0001.H | S0002.H | S0003.H | S0004.H | S0005.H | S0006.H |
| Bone Level RC | | S0011.H | S0012.H | S0013.H | S0014.H | S0015.H | S0016.H |
| Tissue Level NNC | | S0041.H | S0042.H | S0043.H | S0044.H | S0045.H | S0046.H |
| Tissue Level RN | | S0031.H | S0032.H | S0033.H | S0034.H | S0035.H | S0036.H |
| Tissue Level WN | | S0021.H | S0022.H | S0023.H | S0024.H | S0025.H | S0026.H |

ZimVie®

| | | | | | | | |
|-------------------------------------|---------|---------|---------|---------|---------|---------|---------|
| Tapered Screw-Vent® 3.5 mm | Z0000.H | Z0001.H | Z0002.H | Z0003.H | Z0004.H | Z0005.H | Z0006.H |
| Tapered Screw-Vent® 4.5 mm | Z0010.H | Z0011.H | Z0012.H | Z0013.H | Z0014.H | Z0015.H | Z0016.H |
| Tapered Screw-Vent® 5.7 mm | | Z0021.H | Z0022.H | Z0023.H | Z0024.H | Z0025.H | Z0026.H |
| 3i External Hex NP 3.25 mm / 3.4 mm | | Z0031.H | Z0032.H | Z0033.H | Z0034.H | Z0035.H | |
| 3i External Hex RP ø4.1 mm | | Z0061.H | Z0062.H | Z0063.H | Z0064.H | Z0065.H | Z0066.H |
| 3.4mm Certain® Connection | | Z0041.H | Z0042.H | Z0043.H | Z0044.H | Z0045.H | Z0046.H |
| 4.1mm Certain® Connection | | Z0051.H | Z0052.H | Z0053.H | Z0054.H | Z0055.H | Z0056.H |

Docklocs Straight Abutments with All-in-One Packaging

Standard Abutments Packaged with Ancillary Components for Your Convenience

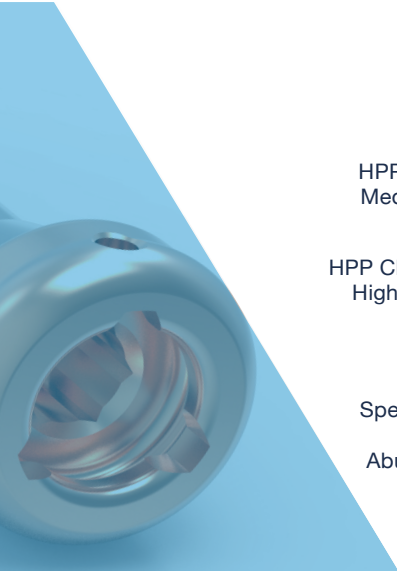

HPP Blue Standard Pivot
Low Retention Insert



HPP Pink Standard Pivot
Medium Retention Insert



HPP Clear Standard Pivot
High Retention Insert



Specified Abutment
with
Abutment Holder /
Parallel Post



Enhanced Denture Cap
with Black Processing Insert



HPP Red Extended Pivot
Low Retention Insert



HPP Orange Extended Pivot
Medium Retention Insert



HPP Green Extended Pivot
High Retention Insert



Block-Out Spacer



Docklocs 18° Angled Abutments with All-in-One Packaging

All Necessary Components to Complete a Case in a Single Package



Abutment Screw



Specified Abutment
with convenient carrier



Enhanced Denture Cap
with Black Processing Insert



HPP Red Extended Pivot
Low Retention Insert



HPP Orange Extended Pivot
Medium Retention Insert



HPP Green Extended Pivot
High Retention Insert



Block-Out Spacer



Abutment Holder /
Parallel Post





| Straight Abutments | Cuff Height | | | | | | |
|--------------------|-------------|-----|-----|-----|-----|-----|-----|
| | 0mm | 1mm | 2mm | 3mm | 4mm | 5mm | 6mm |
| Implant Platform | | | | | | | |

Bego

| | | | | | | | |
|--|--|-----------|-----------|-----------|-----------|-----------|--|
| Sub-Tec S / RI / RS / RSX 3.75 mm-4.1 mm | | B0001.S.T | B0002.S.T | B0003.S.T | B0004.S.T | B0005.S.T | |
| Sub-Tec S / RI / RS / RSX 4.5 mm | | B0011.S.T | B0012.S.T | B0013.S.T | B0014.S.T | B0015.S.T | |

BioHorizons®

| | | | | | | | |
|--|------------|------------|------------|------------|------------|------------|--|
| Tapered Internal Implant System 3.5 mm | BH0000.S.T | BH0001.S.T | BH0002.S.T | BH0003.S.T | BH0004.S.T | BH0005.S.T | |
| Tapered Internal Implant System 4.5 mm | BH0010.S.T | BH0011.S.T | BH0012.S.T | BH0013.S.T | BH0014.S.T | BH0015.S.T | |
| Tapered Internal Implant System 5.7 mm | | BH0021.S.T | BH0022.S.T | BH0023.S.T | BH0024.S.T | BH0025.S.T | |

Bredent

| | | | | | | | |
|----------|--|------------|------------|------------|------------|--|------------|
| SKY® | | BR0001.S.T | BR0002.S.T | BR0003.S.T | BR0004.S.T | | BR0006.S.T |
| copaSKY® | | BR0011.S.T | BR0012.S.T | BR0013.S.T | BR0014.S.T | | BR0016.S.T |

C-TECH IMPLANT

| | | | | | | | |
|--------------------|--|------------|------------|------------|------------|------------|------------|
| EL / Esthetic Line | | CT0001.S.T | CT0002.S.T | CT0003.S.T | CT0004.S.T | CT0005.S.T | CT0006.S.T |
|--------------------|--|------------|------------|------------|------------|------------|------------|

CAMLOG®

| | | | | | | | |
|-----------------|--|-----------|-----------|-----------|-----------|-----------|--|
| iSy® | | C0001.S.T | C0002.S.T | C0003.S.T | C0004.S.T | C0005.S.T | |
| CAMLOG® 3.3 mm | | C0011.S.T | C0012.S.T | C0013.S.T | C0014.S.T | C0015.S.T | |
| CAMLOG® 3.8 mm | | C0021.S.T | C0022.S.T | C0023.S.T | C0024.S.T | C0025.S.T | |
| CAMLOG® 4.3 mm | | C0031.S.T | C0032.S.T | C0033.S.T | C0034.S.T | C0035.S.T | |
| CAMLOG® 5.0 mm | | C0041.S.T | C0042.S.T | C0043.S.T | C0044.S.T | C0045.S.T | |
| CONELOG® 3.3 mm | | C0051.S.T | C0052.S.T | C0053.S.T | C0054.S.T | C0055.S.T | |
| CONELOG® 3.8 mm | | C0061.S.T | C0062.S.T | C0063.S.T | C0064.S.T | C0065.S.T | |
| CONELOG® 4.3 mm | | C0071.S.T | C0072.S.T | C0073.S.T | C0074.S.T | C0075.S.T | |
| CONELOG® 5.0 mm | | C0081.S.T | C0082.S.T | C0083.S.T | C0084.S.T | C0085.S.T | |



| Straight Abutments | Cuff Height | | | | | | | |
|--------------------|-------------|-----|-----|-----|-----|-----|-----|-----|
| | 0mm | 1mm | 2mm | 3mm | 4mm | 5mm | 6mm | 7mm |
| Implant Platform | | | | | | | | |

Dentsply Sirona®

| | | | | | | | |
|--|--|------------|------------|------------|------------|------------|-----------|
| Astra OsseoSpeed® TX Aqua 3.5mm/4mm | | AS0001.S.T | AS0002.S.T | AS0003.S.T | AS0004.S.T | AS0005.S.T | |
| Astra OsseoSpeed® TX Lilac 4.5mm/5mm | | AS0011.S.T | AS0012.S.T | AS0013.S.T | AS0014.S.T | AS0015.S.T | |
| Astra OsseoSpeed® EV 3.6 mm | | AS0021.S.T | AS0022.S.T | AS0023.S.T | AS0024.S.T | AS0025.S.T | |
| Astra OsseoSpeed® EV & Profile EV 4.2 mm | | AS0031.S.T | AS0032.S.T | AS0033.S.T | AS0034.S.T | AS0035.S.T | |
| Astra OsseoSpeed® EV & Profile EV 4.8 mm | | AS0041.S.T | AS0042.S.T | AS0043.S.T | AS0044.S.T | AS0045.S.T | |
| Ankylos® C/X | | D0001.S.T | D0002.S.T | D0003.S.T | D0004.S.T | D0005.S.T | D0006.S.T |

Medentis

| | | | | | | | |
|-----|--|-----------|-----------|-----------|-----------|-----------|--|
| ICX | | M0001.S.T | M0002.S.T | M0003.S.T | M0004.S.T | M0005.S.T | |
|-----|--|-----------|-----------|-----------|-----------|-----------|--|

MegaGen

| | | | | | | | | |
|------------------|--|------------|------------|------------|------------|------------|------------|------------|
| AnyRidge® | | MG0001.S.T | MG0002.S.T | MG0003.S.T | MG0004.S.T | MG0005.S.T | MG0006.S.T | |
| AnyOne® Internal | | MG0021.S.T | MG0022.S.T | MG0023.S.T | MG0024.S.T | MG0025.S.T | MG0026.S.T | |
| AnyOne® Onestage | | MG0011.S.T | MG0012.S.T | MG0013.S.T | MG0014.S.T | MG0015.S.T | MG0016.S.T | |
| MINI™ | | MG0031.S.T | MG0032.S.T | MG0033.S.T | MG0034.S.T | MG0035.S.T | MG0036.S.T | |
| BLUEDIAMOND® NC | | MG0041.S.T | MG0042.S.T | MG0043.S.T | MG0044.S.T | MG0045.S.T | MG0046.S.T | |
| BLUEDIAMOND® RC | | MG0051.S.T | MG0052.S.T | MG0053.S.T | MG0054.S.T | MG0055.S.T | MG0056.S.T | MG0057.S.T |

Neodent®

| | | | | | | | |
|--------------|--|------------|------------|------------|------------|------------|------------|
| Grand Morse® | | NE0001.S.T | NE0002.S.T | NE0003.S.T | NE0004.S.T | NE0005.S.T | NE0006.S.T |
|--------------|--|------------|------------|------------|------------|------------|------------|

Nobel Biocare®

| | | | | | | | |
|-----------------------------------|-----------|-----------|-----------|-----------|-----------|-----------|-----------|
| NobelReplace® Tri-Channel 3.5 mm | N0000.S.T | N0001.S.T | N0002.S.T | N0003.S.T | N0004.S.T | N0005.S.T | N0006.S.T |
| NobelReplace® Tri-Channel 4.3 mm | N0010.S.T | N0011.S.T | N0012.S.T | N0013.S.T | N0014.S.T | N0015.S.T | N0016.S.T |
| NobelReplace® Tri-Channel 5.0 mm | | N0021.S.T | N0022.S.T | N0023.S.T | N0024.S.T | N0025.S.T | N0026.S.T |
| NobelActive® Conical NP | | N0031.S.T | N0032.S.T | N0033.S.T | N0034.S.T | N0035.S.T | N0036.S.T |
| NobelActive® Conical RP | | N0041.S.T | N0042.S.T | N0043.S.T | N0044.S.T | N0045.S.T | N0046.S.T |
| Brånemark System® External Hex NP | | N0051.S.T | N0052.S.T | N0053.S.T | N0054.S.T | N0055.S.T | N0056.S.T |
| Brånemark System® External Hex RP | | N0061.S.T | N0062.S.T | N0063.S.T | N0064.S.T | N0065.S.T | N0066.S.T |
| Brånemark System® External Hex WP | | N0071.S.T | N0072.S.T | N0073.S.T | N0074.S.T | N0075.S.T | |



| Straight Abutments | Cuff Height | | | | | | |
|--------------------|-------------|-----|-----|-----|-----|-----|-----|
| Implant Platform | 0mm | 1mm | 2mm | 3mm | 4mm | 5mm | 6mm |

Osstem® / Hiossen®

| | | | | | | | |
|--|--|-----------|-----------|-----------|-----------|-----------|-----------|
| TS System Mini (Yellow) ET System Mini (Yellow) | | O0001.S.T | O0002.S.T | O0003.S.T | O0004.S.T | O0005.S.T | O0006.S.T |
| TS System Regular (Green) ET System Regular (Green) | | O0011.S.T | O0012.S.T | O0013.S.T | O0014.S.T | O0015.S.T | O0016.S.T |

Southern Implants®

| | | | | | | | |
|------------------------------|------------|-------------|-------------|-------------|-------------|-------------|-------------|
| External Hex 3.0 mm | | SI0001.S.T | SI0002.S.T | SI0003.S.T | SI0004.S.T | SI0005.S.T | SI0006.S.T |
| External Hex 3.25 mm | | SI0011.S.T | SI0012.S.T | SI0013.S.T | SI0014.S.T | SI0015.S.T | SI0016.S.T |
| External Hex 4.0 mm | | SI0021.S.T | SI0022.S.T | SI0023.S.T | SI0024.S.T | SI0025.S.T | SI0026.S.T |
| Tri Nex® 3.5 mm | SI0070.S.T | SI0071.S.T | SI0072.S.T | SI0073.S.T | SI0074.S.T | SI0075.S.T | SI0076.S.T |
| Tri Nex® 4.3 mm | SI0080.S.T | SI0081.S.T | SI0082.S.T | SI0083.S.T | SI0084.S.T | SI0085.S.T | SI0086.S.T |
| Tri Nex® 5.0 mm | | SI0091.S.T | SI0092.S.T | SI0093.S.T | SI0094.S.T | SI0095.S.T | SI0096.S.T |
| Deep Conical 3.0 mm | | SI00101.S.T | SI00102.S.T | SI00103.S.T | SI00104.S.T | SI00105.S.T | SI00106.S.T |
| Deep Conical 3.5 mm / 4.0 mm | | SI00111.S.T | SI00112.S.T | SI00113.S.T | SI00114.S.T | SI00115.S.T | |
| Deep Conical 5.0 mm | | SI00121.S.T | SI00122.S.T | SI00123.S.T | SI00124.S.T | SI00125.S.T | |
| Internal Hex/Provata | SI0040.S.T | SI0041.S.T | SI0042.S.T | SI0043.S.T | SI0044.S.T | SI0045.S.T | SI0046.S.T |
| Internal Provata 3.3 mm | | | SI0052.S.T | | SI0054.S.T | | |
| IT Connection 4.8 mm | | SI00131.S.T | SI00132.S.T | SI00133.S.T | SI00134.S.T | SI00135.S.T | SI00136.S.T |
| IT Connection 6.5 mm | | SI00141.S.T | SI00142.S.T | SI00143.S.T | SI00144.S.T | SI00145.S.T | SI00146.S.T |
| SP1 | | SI00151.S.T | SI00152.S.T | SI00153.S.T | SI00154.S.T | SI00155.S.T | SI00156.S.T |

Straumann®

| | | | | | | | |
|------------------|--|-----------|-----------|-----------|-----------|-----------|-----------|
| Bone Level NC | | S0001.S.T | S0002.S.T | S0003.S.T | S0004.S.T | S0005.S.T | S0006.S.T |
| Bone Level RC | | S0011.S.T | S0012.S.T | S0013.S.T | S0014.S.T | S0015.S.T | S0016.S.T |
| Tissue Level NNC | | S0041.S.T | S0042.S.T | S0043.S.T | S0044.S.T | S0045.S.T | S0046.S.T |
| Tissue Level RN | | S0031.S.T | S0032.S.T | S0033.S.T | S0034.S.T | S0035.S.T | S0036.S.T |
| Tissue Level WN | | S0021.S.T | S0022.S.T | S0023.S.T | S0024.S.T | S0025.S.T | S0026.S.T |

ZimVie®

| | | | | | | | |
|-------------------------------------|-----------|-----------|-----------|-----------|-----------|-----------|-----------|
| Tapered Screw-Vent® 3.5 mm | Z0000.S.T | Z0001.S.T | Z0002.S.T | Z0003.S.T | Z0004.S.T | Z0005.S.T | Z0006.S.T |
| Tapered Screw-Vent® 4.5 mm | Z0010.S.T | Z0011.S.T | Z0012.S.T | Z0013.S.T | Z0014.S.T | Z0015.S.T | Z0016.S.T |
| Tapered Screw-Vent® 5.7 mm | | Z0021.S.T | Z0022.S.T | Z0023.S.T | Z0024.S.T | Z0025.S.T | Z0026.S.T |
| 3i External Hex NP 3.25 mm / 3.4 mm | | Z0031.S.T | Z0032.S.T | Z0033.S.T | Z0034.S.T | Z0035.S.T | |
| 3i External Hex RP 4.1 mm | | Z0061.S.T | Z0062.S.T | Z0063.S.T | Z0064.S.T | Z0065.S.T | Z0066.S.T |
| 3.4 mm Certain® Connection | | Z0041.S.T | Z0042.S.T | Z0043.S.T | Z0044.S.T | Z0045.S.T | Z0046.S.T |
| 4.1 mm Certain® Connection | | Z0051.S.T | Z0052.S.T | Z0053.S.T | Z0054.S.T | Z0055.S.T | Z0056.S.T |



| 18° Angled Abutments | | Cuff Height | | | | | |
|----------------------|-----------------|-------------|-----|-----|-----|-----|-----|
| Implant Platform | Variation (A/B) | 1mm | 2mm | 3mm | 4mm | 5mm | 6mm |

Bego

| | | | | | | | |
|--|---|-----------|-----------|-----------|-----------|-----------|--|
| Sub-Tec S / RI / RS / RSX 3.75mm-4.1mm | A | B0701.S.T | B0702.S.T | B0703.S.T | B0704.S.T | B0705.S.T | |
| Sub-Tec S / RI / RS / RSX 3.75mm-4.1mm | B | B0801.S.T | B0802.S.T | B0803.S.T | B0804.S.T | B0805.S.T | |
| Sub-Tec S / RI / RS / RSX 4.5 mm | A | B0711.S.T | B0712.S.T | B0713.S.T | B0714.S.T | B0715.S.T | |
| Sub-Tec S / RI / RS / RSX 4.5 mm | B | B0811.S.T | B0812.S.T | B0813.S.T | B0814.S.T | B0815.S.T | |

BioHorizons®

| | | | | | | | |
|--|---|------------|------------|------------|------------|------------|--|
| Tapered Internal Implant System 3.5 mm | A | BH0701.S.T | BH0702.S.T | BH0703.S.T | BH0704.S.T | BH0705.S.T | |
| Tapered Internal Implant System 3.5 mm | B | BH0801.S.T | BH0802.S.T | BH0803.S.T | BH0804.S.T | BH0805.S.T | |

Bredent

| | | | | | | | |
|----------|--|--|------------|--|------------|------------|--|
| SKY® | | | BR0702.S.T | | BR0704.S.T | BR0705.S.T | |
| copaSKY® | | | BR0712.S.T | | BR0714.S.T | BR0715.S.T | |

CAMLOG®

| | | | | | | | |
|-----------------|---|-----------|-----------|-----------|-----------|-----------|--|
| iSy® | A | C0701.S.T | C0702.S.T | C0703.S.T | C0704.S.T | C0705.S.T | |
| iSy® | B | C0801.S.T | C0802.S.T | C0803.S.T | C0804.S.T | C0805.S.T | |
| CAMLOG® 3.3 mm | A | C0711.S.T | C0712.S.T | C0713.S.T | C0714.S.T | C0715.S.T | |
| CAMLOG® 3.3 mm | B | C0811.S.T | C0812.S.T | C0813.S.T | C0814.S.T | C0815.S.T | |
| CAMLOG® 3.8 mm | A | C0721.S.T | C0722.S.T | C0723.S.T | C0724.S.T | C0725.S.T | |
| CAMLOG® 3.8 mm | B | C0821.S.T | C0822.S.T | C0823.S.T | C0824.S.T | C0825.S.T | |
| CAMLOG® 4.3 mm | A | C0731.S.T | C0732.S.T | C0733.S.T | C0734.S.T | C0735.S.T | |
| CAMLOG® 4.3 mm | B | C0831.S.T | C0832.S.T | C0833.S.T | C0834.S.T | C0835.S.T | |
| CAMLOG® 5.0 mm | A | C0741.S.T | C0742.S.T | C0743.S.T | C0744.S.T | C0745.S.T | |
| CAMLOG® 5.0 mm | B | C0841.S.T | C0842.S.T | C0843.S.T | C0844.S.T | C0845.S.T | |
| CONELOG® 3.3 mm | A | C0751.S.T | C0752.S.T | C0753.S.T | C0754.S.T | C0755.S.T | |
| CONELOG® 3.3 mm | B | C0851.S.T | C0852.S.T | C0853.S.T | C0854.S.T | C0855.S.T | |
| CONELOG® 3.8 mm | A | C0761.S.T | C0762.S.T | C0763.S.T | C0764.S.T | C0765.S.T | |
| CONELOG® 3.8 mm | B | C0861.S.T | C0862.S.T | C0863.S.T | C0864.S.T | C0865.S.T | |
| CONELOG® 4.3 mm | A | C0771.S.T | C0772.S.T | C0773.S.T | C0774.S.T | C0775.S.T | |
| CONELOG® 4.3 mm | B | C0871.S.T | C0872.S.T | C0873.S.T | C0874.S.T | C0875.S.T | |
| CONELOG® 5.0 mm | A | C0781.S.T | C0782.S.T | C0783.S.T | C0784.S.T | C0785.S.T | |
| CONELOG® 5.0 mm | B | C0881.S.T | C0882.S.T | C0883.S.T | C0884.S.T | C0885.S.T | |



| 18° Angled Abutments | | Cuff Height | | | | | |
|----------------------|-----------------|-------------|-----|-----|-----|-----|-----|
| Implant Platform | Variation (A/B) | 1mm | 2mm | 3mm | 4mm | 5mm | 6mm |

C-TECH IMPLANT

| | | | | | | | |
|--------------------|--|------------|------------|------------|--|------------|--|
| EL / Esthetic Line | | CT0701.S.T | CT0702.S.T | CT0703.S.T | | CT0705.S.T | |
|--------------------|--|------------|------------|------------|--|------------|--|

Dentsply Sirona®

| | | | | | | | |
|--|---|------------|------------|------------|------------|------------|--|
| Astra OsseoSpeed® TX Aqua 3.5mm/4mm | A | AS0701.S.T | AS0702.S.T | AS0703.S.T | AS0704.S.T | AS0705.S.T | |
| Astra OsseoSpeed® TX Lilac 4.5mm/5mm | A | AS0711.S.T | AS0712.S.T | AS0713.S.T | AS0714.S.T | AS0715.S.T | |
| Astra OsseoSpeed® EV 3.6 mm | A | AS0721.S.T | AS0722.S.T | AS0723.S.T | AS0724.S.T | AS0725.S.T | |
| Astra OsseoSpeed® EV 3.6 mm | B | AS0821.S.T | AS0822.S.T | AS0823.S.T | AS0824.S.T | AS0825.S.T | |
| Astra OsseoSpeed® EV & Profile EV 4.2 mm | A | AS0731.S.T | AS0732.S.T | AS0733.S.T | AS0734.S.T | AS0735.S.T | |
| Astra OsseoSpeed® EV & Profile EV 4.2 mm | B | AS0831.S.T | AS0832.S.T | AS0833.S.T | AS0834.S.T | AS0835.S.T | |
| Astra OsseoSpeed® EV & Profile EV 4.8 mm | A | AS0741.S.T | AS0742.S.T | AS0743.S.T | AS0744.S.T | AS0745.S.T | |
| Astra OsseoSpeed® EV & Profile EV 4.8 mm | B | AS0841.S.T | AS0842.S.T | AS0843.S.T | AS0844.S.T | AS0845.S.T | |
| Ankylos® C/X | A | D0701.S.T | D0702.S.T | D0703.S.T | D0704.S.T | D0705.S.T | |

Medentis

| | | | | | | | |
|-----|---|-----------|-----------|-----------|-----------|-----------|--|
| ICX | A | M0701.S.T | M0702.S.T | M0703.S.T | M0704.S.T | M0705.S.T | |
| ICX | B | M0801.S.T | M0802.S.T | M0803.S.T | M0804.S.T | M0805.S.T | |

MegaGen

| | | | | | | | |
|------------------|---|---------------------------|------------|---------------------------|---------------------------|------------|---------------------------|
| AnyRidge® | A | MG0701.S.T (GH 1,5 mm) | | MG0702.S.T (GH 3,0 mm) | MG0703.S.T (GH 4,5 mm) | | |
| AnyRidge® | B | MG0801.S.T (GH 1,5 mm) | | MG0802.S.T (GH 3,0 mm) | MG0803.S.T (GH 4,5 mm) | | |
| AnyOne® Onestage | A | MG0711.S.T | MG0712.S.T | MG0713.S.T | MG0714.S.T | MG0715.S.T | |
| BLUEDIAMOND® NC | A | MG0741.S.T (GH 1,5 mm) | | MG0742.S.T (GH 3,0 mm) | MG0743.S.T (GH 4,5 mm) | | MG0744.S.T (GH 6,0 mm) |
| BLUEDIAMOND® RC | A | MG0751.S.T (GH 1,5 mm) | | MG0752.S.T (GH 3,0 mm) | MG0753.S.T (GH 4,5 mm) | | MG0754.S.T (GH 6,0 mm) |

Nobel Biocare®

| | | | | | | | |
|-----------------------------------|---|-----------|-----------|-----------|-----------|-----------|--|
| NobelReplace® Tri-Channel 3.5 mm | A | N0701.S.T | N0702.S.T | N0703.S.T | N0704.S.T | N0705.S.T | |
| NobelReplace® Tri-Channel 4.3 mm | A | N0711.S.T | | N0713.S.T | | N0715.S.T | |
| NobelActive® Conical NP | A | N0731.S.T | | N0733.S.T | | N0735.S.T | |
| NobelActive® Conical RP | A | N0741.S.T | | N0743.S.T | | N0745.S.T | |
| Brånemark System® External Hex NP | A | N0751.S.T | | N0753.S.T | | N0755.S.T | |
| Brånemark System® External Hex RP | A | N0761.S.T | N0762.S.T | N0763.S.T | N0764.S.T | N0765.S.T | |



| 18° Angled Abutments | | Cuff Height | | | | | |
|----------------------|-----------------|-------------|-----|-----|-----|-----|-----|
| Implant Platform | Variation (A/B) | 1mm | 2mm | 3mm | 4mm | 5mm | 6mm |

Southern Implants®

| | | | | | | | |
|------------------------------|---|-------------|-------------|-------------|-------------|-------------|--|
| External Hex 3.25 mm | A | SI0711.S.T | | SI0713.S.T | | SI0715.S.T | |
| External Hex 4.0 mm | A | SI0721.S.T | SI0722.S.T | SI0723.S.T | SI0724.S.T | SI0725.S.T | |
| TRI-NEX® 3.5 mm | A | SI0771.S.T | SI0772.S.T | SI0773.S.T | SI0774.S.T | SI0775.S.T | |
| TRI-NEX® 4.3 mm | A | SI0781.S.T | | SI0783.S.T | | SI0785.S.T | |
| Deep Conical 3.5 mm / 4.0 mm | A | SI07111.S.T | SI07112.S.T | SI07113.S.T | SI07114.S.T | SI07115.S.T | |
| Deep Conical 5.0 mm | A | SI07121.S.T | SI07122.S.T | SI07123.S.T | SI07124.S.T | SI07125.S.T | |
| Internal Hex/Provata | A | SI0741.S.T | SI0742.S.T | SI0743.S.T | SI0744.S.T | SI0745.S.T | |
| Internal Hex/Provata | B | SI0841.S.T | SI0842.S.T | SI0843.S.T | SI0844.S.T | SI0845.S.T | |
| IT Connection 4.8 mm | A | SI07131.S.T | SI07132.S.T | SI07133.S.T | SI07134.S.T | SI07135.S.T | |
| IT Connection 6.5 mm | A | SI07141.S.T | SI07142.S.T | SI07143.S.T | SI07144.S.T | SI07145.S.T | |

Straumann®

| | | | | | | | |
|-----------------|---|-----------|-----------|-----------|-----------|-----------|--|
| Bone Level NC | A | S0701.S.T | S0702.S.T | S0703.S.T | S0704.S.T | S0705.S.T | |
| Bone Level NC | B | S0801.S.T | S0802.S.T | S0803.S.T | S0804.S.T | S0805.S.T | |
| Bone Level RC | A | S0711.S.T | S0712.S.T | S0713.S.T | S0714.S.T | S0715.S.T | |
| Bone Level RC | B | S0811.S.T | S0812.S.T | S0813.S.T | S0814.S.T | S0815.S.T | |
| Tissue Level RN | A | S0731.S.T | S0732.S.T | S0733.S.T | S0734.S.T | S0735.S.T | |
| Tissue Level WN | A | S0721.S.T | S0722.S.T | S0723.S.T | S0724.S.T | S0725.S.T | |

ZimVie®

| | | | | | | | |
|-------------------------------------|---|-----------|-----------|-----------|-----------|-----------|--|
| Tapered Screw-Vent® 3.5 mm | A | Z0701.S.T | Z0702.S.T | Z0703.S.T | Z0704.S.T | Z0705.S.T | |
| Tapered Screw-Vent® 3.5 mm | B | Z0801.S.T | Z0802.S.T | Z0803.S.T | Z0804.S.T | Z0805.S.T | |
| Tapered Screw-Vent® 4.5 mm | A | Z0711.S.T | | Z0713.S.T | | Z0715.S.T | |
| 3i External Hex NP 3.25 mm / 3.4 mm | A | Z0731.S.T | | Z0733.S.T | | Z0735.S.T | |
| 3i External Hex RP 4.1 mm | A | Z0761.S.T | Z0762.S.T | Z0763.S.T | Z0764.S.T | Z0765.S.T | |
| 4.1 mm Certain® Connection | A | Z0751.S.T | | Z0753.S.T | | Z0755.S.T | |

Cuff Height Selection

1. With a periodontal probe, measure the highest point of the gingiva from the top of the implant.
2. Select the Docklocs abutment cuff height that best corresponds to that measurement. If the measurement is 3 mm, select the 3 mm cuff height. If the measurement is 3,5 mm, select the 4 mm cuff. An additional 1,75 mm of the abutment will extend above the gingiva to allow the prosthesis to be properly seated without tissue impingement. Cuff height measurements for angled abutments are to be determined with the same process. **If you are unsure about the correct cuff height for your case, please contact us.**



Order the correct abutment every time with the innovative

Docklocs Selection Abutments

Available for a variety of implant platforms*, Docklocs Selection Abutments take the guesswork out of abutment ordering. Our Selection Abutments allow you to choose the appropriate angulation (straight or 18° angled) for the restoration. To best utilize the anti-rotational features of each connection, angled Docklocs abutments are available in “A” and “B” variants.

Docklocs Selection Abutment packs include representations of straight abutments in a variety of cuff heights in order for you to verify your measurement and visualize the final abutment.

*New connections are being added on a regular basis, so please consult with your Docklocsdistributor for currently available Selection Abutments.

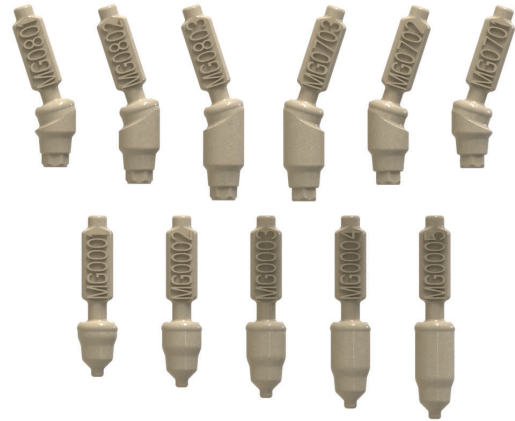

Bego

| | |
|--|---------|
| Sub-Tec S / RI / RS / RSX 3.75 mm - 4.1 mm | AWB00.S |
| Sub-Tec S / RI / RS / RSX 4.5 mm | AWB01.S |

CAMLOG®

| | |
|-----------------|---------|
| CAMLOG® 3.3 mm | AWC01.S |
| CAMLOG® 3.8 mm | AWC02.S |
| CAMLOG® 4.3 mm | AWC03.S |
| CONOLOG® 3.8 mm | AWC06.S |
| CONOLOG® 4.3 mm | AWC07.S |

C-TECH IMPLANT

| | |
|--------------------|----------|
| EL / Esthetic Line | AWCT00.S |
|--------------------|----------|

Dentsply Sirona®

| | |
|--|----------|
| Astra OsseoSpeed® TX Aqua 3.5 mm / 4 mm | AWAS00.S |
| Astra OsseoSpeed® EV 3.6 mm | AWAS02.S |
| Astra OsseoSpeed® EV and Profile EV 4.2 mm | AWAS03.S |
| Ankylos® C/X | AWD00.S |

Medentis

| | |
|-----|---------|
| ICX | AWM00.S |
|-----|---------|

MegaGen

| | |
|------------------|----------|
| AnyRidge® | AWMG00.S |
| AnyOne® Onestage | AWMG01.S |
| BLUEDIAMOND®NC | AWMG04.S |
| BLUEDIAMOND®RC | AWMG05.S |

Nobel Biocare®

| | |
|-----------------------------------|---------|
| NobelReplace® Tri-Channel 3.5 mm | AWN00.S |
| NobelReplace® Tri-Channel 4.3 mm | AWN01.S |
| NobelActive® Conical NP | AWN03.S |
| NobelActive® Conical RP | AWN04.S |
| Brånemark System® External Hex NP | AWN05.S |
| Brånemark System® External Hex RP | AWN06.S |

Straumann®

| | |
|-----------------|---------|
| Bone Level NC | AWS00.S |
| Bone Level RC | AWS01.S |
| Tissue Level RN | AWS03.S |

ZimVie®

| | |
|-------------------------------------|---------|
| Tapered Screw-Vent® 3.5 mm | AWZ00.S |
| Tapered Screw-Vent® 4.5 mm | AWZ01.S |
| 3i External Hex NP 3.25 mm / 3.4 mm | AWZ03.S |

Docklocs®

OVERDENTURE ATTACHMENT SYSTEM

Distributed By:

≡ MEDEALIS

Im Steinböhl 9
69518 Abtsteinach
Germany
www.medealis.de
+49 6207 2032 597



Docklocs® is a registered trademark of MEDEALIS GmbH. BioHorizons® is a registered trademark of BioHorizons. CAMLOG®, CONELOG® and iSy® are registered trademarks of CAMLOG Biotechnologies AG. Dentsply Sirona®, OsseoSpeed® and Ankylos® are registered trademarks of Dentsply Sirona. AnyRidge®, BLUEDIAMOND®, MINI™ and AnyOne® are registered trademarks of MegaGen Implant Co., Ltd. Nobel Biocare®, Brånemark System®, NobelActive®, NobelReplace® and NobelSpeedy® are registered trademarks and NobelParallel™ and Replace Select™ are trademarks of Nobel Biocare Group. Co-Axis® is a registered trademark, PROVATA® and Tri-Nex™ is a trademark of Southern Implants. Southern Implants® is a registered trademark of Southern Implants (Pty) Ltd. ZimVie®, Certain®, AdVent®, ScrewVent® and Tapered ScrewVent® are registered trademarks of ZimVie Inc. or an affiliate of ZimVie Inc.. Straumann®, Neodent® and Grand Morse® are registered trademarks of Straumann Holding AG. Osstem® and Hiossen® are registered trademarks of Osstem Implant Co., Ltd. Please refer to individual product labeling or instructions for use for additional product information. Product availability may be limited to select countries and/or regions depending on regulatory clearances. Consult with your local distributor for more information. This material is intended for clinicians only and does not comprise medical advice or recommendations. This material may not be copied or reprinted without the express consent of MEDEALIS GmbH.